



Demo Practice Guide: Bias Tape Applique

I enjoyed my presentation and demos that I had with the Brown Sugar Stitchers Quilt Guild so much!

If you would like to take what you learn and practice here are a few things that you can do to prep to create a few practice blocks. This practice guide will set you up to try the technique making a Rocket 88 Quilt.

Download [Rocket 88 from the Robert Kaufman website](https://www.robertkaufman.com/assets/pdf/Rocket88.pdf): <https://www.robertkaufman.com/assets/pdf/Rocket88.pdf>

Latifah Saafir Studios Curved Piecing Resources:

[YouTube Channel](https://www.youtube.com/latifahsaafirstudios): <https://www.youtube.com/latifahsaafirstudios>

[Bias Tape Applique Demo with Fresh Quilting](https://www.youtube.com/watch?v=4RinV55gyDE): <https://www.youtube.com/watch?v=4RinV55gyDE>
[Products to help with Bias Tape Applique](#)

Airshow Quilt
No Latitude Quilt

Comin back soon: Bias Tape Applique class at Craftsy.

Discount Code for my website shop.latifahsaafirstudios.com (Valid until 8/18/2020):

BrownSugarStitchers



Bias Tape

Cutting Bias Tape Strips

This technique can be used to cut any size piece of fabric into bias strips! It is much more manageable if it is less than a yard. Square up the fabric first.

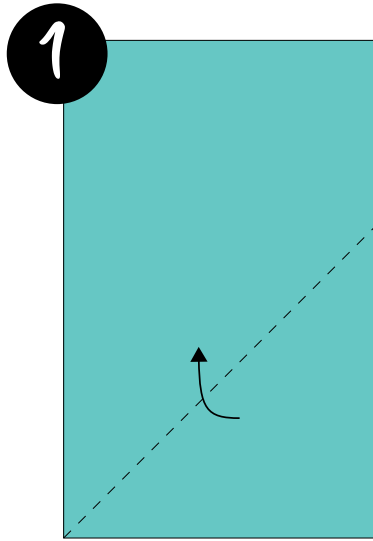

Open fabric up so that it is one layer. Fold diagonally lining up the crosswise grain on the end with the selvage.

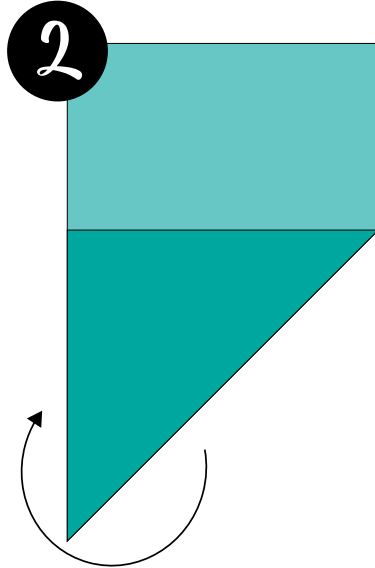

This will create a diagonal 45° fold on the bias. Rotate whole piece so that the fold is parallel to your body.

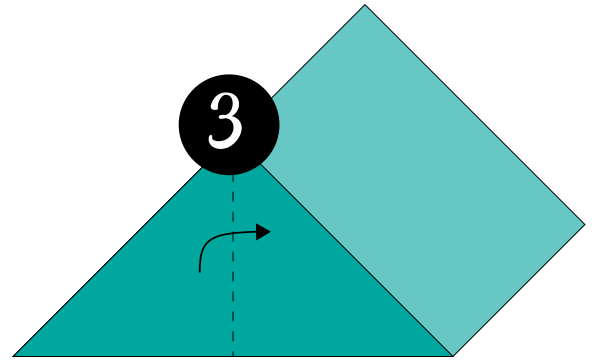

Now you will start to fold a square/rectangle based on that initial fold. First fold to create a vertical line at a 90° angle to the first fold.

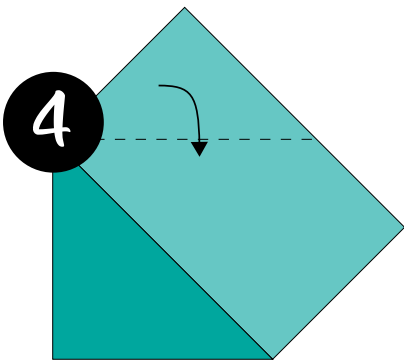

Next make a fold parallel to the first fold and 90° from the vertical fold.

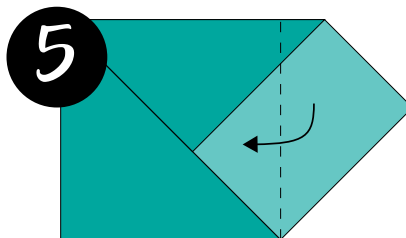

Lastly, make another vertical fold at a 90° angle to the first fold.

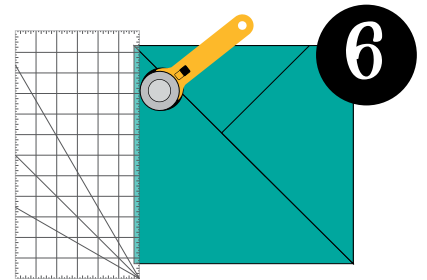

Using a rotary cutter and ruler trim off the fold to create a clean straight edge on one side of the rectangle.

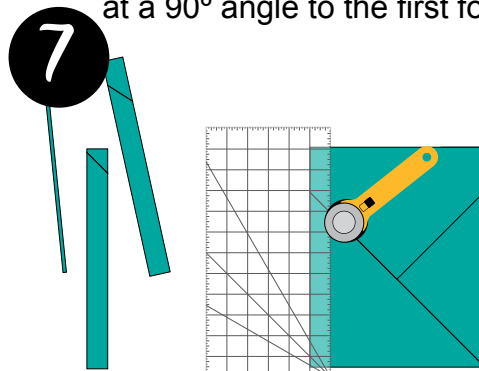

Slide ruler over and cut remaining fabric into bias strips of the desired width.



Making Bias Tape

Sew Bias Tape Strips Together

Place strips right sides together at a 90° angle overlapping the ends as shown below. Pin.

Note: It doesn't matter if the ends of the strip are cut straight - just overlap them so that you can see the full width of each strip beyond the edge of the other strip.

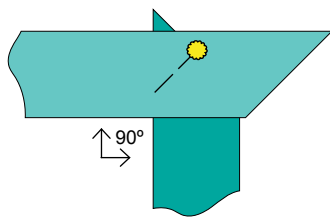

Rotate and sew a straight line from the top point where the strips cross to the bottom point where they cross.

If you're having trouble sewing the line straight, draw the line first using an erasable fabric marker.

Note: You'll know the strips are oriented properly at your machine if the length of the both strips is to the left of the needle and just the ends are to the right.

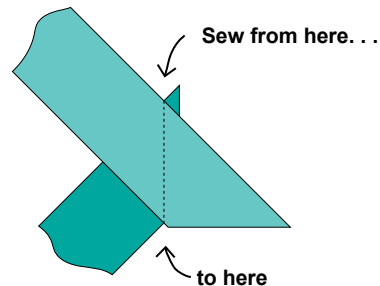

Trim Bias Tape

Using a small pair of fabric scissors, trim using these three steps.

1

A diagram for step 1 showing the two fabric strips with a dashed line indicating the trim line. A small triangle of fabric is shown being cut away from the overlap.

Using the outside edge of one bias strip as a guide trim the overlap flush to that side.

2

A diagram for step 2 showing the two fabric strips with a dashed line indicating the trim line. A small triangle of fabric is shown being cut away from the overlap.

Cut diagonally 1/4" from seam line.

3

A diagram for step 3 showing the two fabric strips with a dashed line indicating the trim line. A small triangle of fabric is shown being cut away from the overlap.

Lastly, trim overlap at top flush with the outside edge of second strip.

Press Bias Tape

Using a Bias Tape Maker by Dritz or Clover, follow the directions in the package to press your bias strips into bias tape.